



HK-1000

User Manual

- To ensure safety and proper use, please read this manual carefully and follow the instruction herein before use.
- Images and screens in the manual may differ from the actual product.

<How to use KASSE device>

Button operation

Use the two left and right Buttons to operate.

Button 1 is mainly used to change items. Button 2 is used for selection.

If there is no icon for selection or confirmation at the top of the screen and only the direction or cancel icon is displayed, Press Button 1+ 2 at the same time to execute the operation for confirmation or selection.

<Supported key combinations>

Press Button 1

Press Button 2

Press 1 + 2 Buttons

Press Button 1 and hold

Press Button 2 and hold

Press Button 1 + 2 and hold

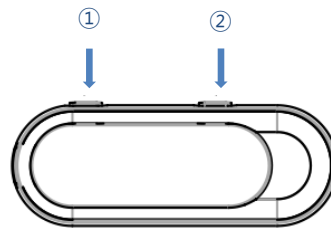

By default, there are six Buttons for specifying the Button actions displayed.



"Left", "Right", "Up", "Down", "Confirm", "Cancel" respectively.

Enter PIN



- **Button ① (left)**
Performs the operation of changing numbers from 0 to 9.
- **Button ② (Right)**
Confirm the change with Button 1 and go to the next number input.
- **Press Button 2 and hold**
Acts as delete button.
Cancel input of current position and move to previous position.
- **Press Buttons 1 + 2 at the same time.**
Go to the final confirmation of the entered PIN number.

Move and Select menu

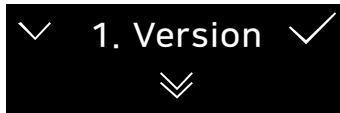

- ∨It indicates that there is next menu item and it moves with Button 1.
- Press Button 1 to change the menu item and then select it with Button 2.
- Go to previous menu
-Since there is no Button to move to the previous menu, the "Back" menu Move to item and select it.
- Press Button 1 to move to the 'Back' menu item and Press Button 2 .

After select each menu, the following Items required to press Button 1 + 2 at the same time.

- Factory reset
- Adjust the screen brightness
- Repair and create wallet
- Entering PIN number completed
- Select character when entering Passphrase

Items that must press Button 1 + 2 at the same time and hold.

- Passphrase text input completed

< Initial setting method >

PIN number and wallet are not created when the first booting after purchase.

You need to set up your Language, PIN and wallet as follows:

Language Setting

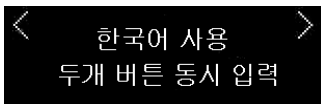

- If you want to change to English mode, press any key.

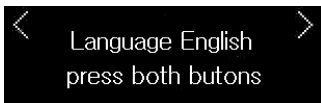

- Press the button 1 + 2 at the same time.

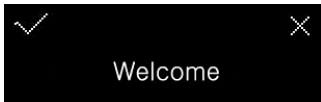

- Press Button 1 to complete the language selection. If you want to change current setting, press Button 2 and select again.

Create PIN code

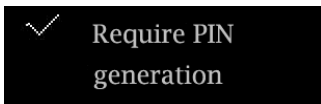

- Press Button 1



- Press Button 1 to change the number.
- Press Button 2 to select the number and move to the next selection. When you finish selecting the PIN code, press Button 1 + 2 shortly to save the PIN code. Enter the same PIN code again to finish the setup.

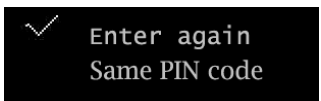

- Enter the same PIN code again after press Button 1.

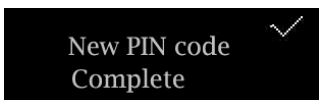

- Press Button 2 to move to the next step.

Choose Create Wallet or Recovery Mode

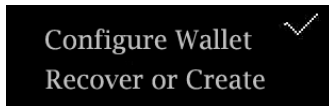

Once the PIN code is generated, go to the Create or Recovery Mode.

- Press Button 2

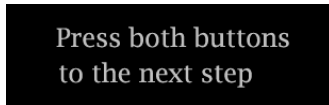

- Press the Button 1 + 2 at the same time to move to the next step.

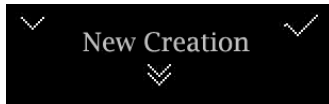

- Press Button 1 to change the "New Creation" or "Recovery".



- Press Button 2 to move to the next step.

We described "Create a new wallet". "Recovery wallet" has the similar steps, so no description is given.

Passphrase input step

You can add or cancel a passphrase, but it is recommended to add it for your personal information security, and you must record your passphrase with 'a Word list' and keep it in a safe place.

If you lose any of them, you will not be able to recover your wallet.

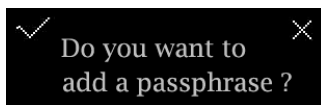

If you cancel, you will go to create Word list step.

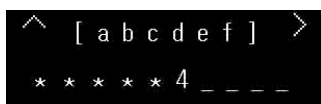

- Button 1 : To change character.
- Button 2 : To change character array
- Button 1 + 2 : Selects the displayed character and moves to the next input
- Press Button 1 + 2 and hold : Go to the final confirmation step

If you see the character you want to input, change it to the corresponding character with Button 1 and press the Button 1 + 2 at the same time to go to the next character entry. If you try to complete the input with selected characters, press Button 1 + 2 at the same time and hold to complete the setup.

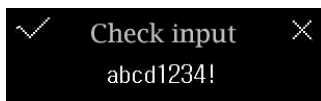

Please record the passphrase Word list shown on the screen in the enclosed sheet.

Create Word list

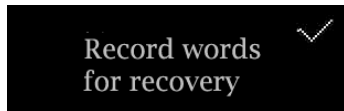

- Press Button 2

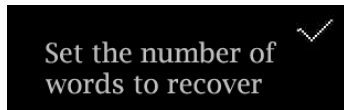

- Press Button 2



You can choose from 3 to 24 words.

- Press Button 1 to change word count.

Press Button 2 to select number of words that you want. .

We recommend you to choose a higher number for better security.



Selected numbers of random words will be displayed.

- Press the Buttons 1 + 2 to move to the left or right to check the words. Please record the words displayed on the enclosed recording sheet in the order of display.

Please keep the Word list with passphrase. You cannot restore wallet if you lose it.

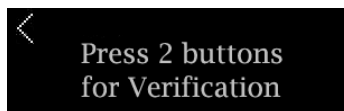

Press Button 2 to move to the final step to confirm the entered Word list and Passphrase again.

- Press Button 1 + 2 at the same time.

Passphrase input value verification step

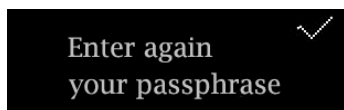

- Enter the passphrase with "Passphrase input step".

If it matches the previously entered value, it goes to the Word list confirmation step.

If your passphrase input is canceled in the wallet create step, you will be moved directly to the Word list confirmation step.

Word list confirmation step

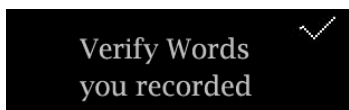

- Randomly select 3 words from the Word lists and select those words in the order that match with the previously recorded words.

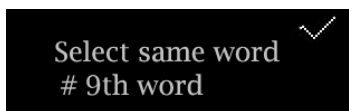

- When you press Button 2, words are displayed in random order. Check the words on the screen in the sequence shown on the display.



- Find the word that matches the order and press Button 1 + 2 at the same time. Select three words in the same way.

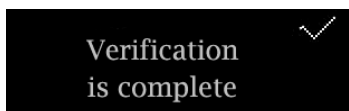

- Press Button 2 to start creating a new wallet. If you want to cancel the creating wallet, please disconnect the USB connection. If you do not proceed to the next step, your wallet will not be created

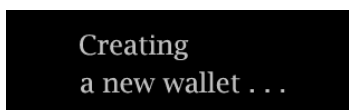

- It takes about 4-5 seconds to newly create wallet. If the power is cut-off during this process or the wallet is not created normally, you can either restart creating wallet from the beginning or recover your wallet through the recorded recovery texts.

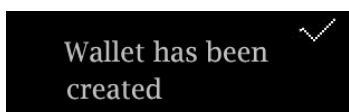

- The wallet has been successfully created. You will be able to use your device normally after you press Button 2,

Wallet recovery

Wallet recovery is the process of restoring your wallet with the Word list that you choose when you create a new wallet. The process is similar to create a new wallet, but the Words in the word list must be typed in order to restore the wallet. If you have created a wallet with additional passphrase, you must also restore the same passphrase to recover the wallet with the same information.

How to create a secure wallet

After creating a new wallet, select "Factory Reset" and then "Repair Wallet". It is recommended that you select "Restore Wallet" from the "Wallet Settings" menu. This is the simplest but most reliable method of self-diagnosing the validity of the Word list and passphrase you wrote down when you create a new wallet.

< How to use Recovery Card >

When you create a new wallet, you must record your passphrase and Word list in order. If you lose your device, factory reset, or re-create a new wallet, your Wallet information will be available only through recovery. In this case, you can recover the same wallet using the passphrase and Word list recorded on the recovery card. Cards with recovery statements must be kept in a safe place to ensure they are not lost. You cannot recover your wallet if you lose it.

< General Operation Description >

Create wallet

The words and passphrase that appear while creating your wallet must be recorded on the enclosed sheet. It is possible to recover by using the recorded word and passphrase when lost or initialized. If the recorded contents are lost, it cannot be recovered.

The number of recovery words can be from 3 to 24.

If you want high security, we recommend choosing many words.

The passphrase is optional and will be entered by the user only when the input is selected.

There is a procedure to reconfirm what was entered in the final step to prevent a random wallet creating.

Be sure to record your Word list and passphrase so that they are not lost. The order of the words is important, so they must be recorded exactly in the order in which they appear.

"It cannot be recovered when lost."

Wallet recovery

You can recover your existed wallet when you use a new device or when the device is reset.

In the recovery phase, you can recover your wallet by entering the Word list and passphrase that you recorded during the wallet create process.

If you did not add a passphrase when you created your wallet, please cancel the passphrase entry process and proceed with the restoration only by entering the word.

You must enter the same information while you used to create your wallet to recover the same wallet.

If you enter only 3 alphabetic characters, you can see the list of words that can be selected.

Error occurred during information input

If your wallet did not actually enter the "in progress" or "completed" state, remove USB from your device so you can re-start "Create a new wallet" or "recovery" process by reconnecting USB.

PIN Number

To use the booting device, you need to enter the PIN number.

You can set your own numbers that has 4 to 10 digits.

If you enter the wrong PIN number ten times in the initial booting sequence, all the wallet information of the device will be initialized. This is to prevent entering the wrong information in case of someone try to manipulate the product.

When the device is initialized due to a 10-time PIN failure, the generated wallet will also be deleted, so you must regenerate it through "Repair Wallet".

Word list and Passphrase

A set of personal passphrases will be used when creating an encrypted key for wallet create. You can use the Word list alone or you can add an additional passphrase to your Word list that corresponds to your personal password. Since the information entered is not stored in the product's memory, it must be stored on the enclosed record sheet or other paper. It is mandatory to recover your wallet and **cannot be recovered if lost**. If you record the words that are displayed on your device in order, and you have entered additional passphrases, please record them together and keep them in a safe place.

Passphrase is optional. If you canceled the input the passphrase when you create a new wallet, then the wallet would be created with the Word list only, so only the Word list would be required when restoring the wallet.

<Safety Instructions>

- Do not disassemble, modify or repair the product. Free repair is not available within the warranty period. If a malfunction occurs, please contact the designated A / S center or the seller.
- Do not place the product near heat sources such as radiators, stoves, etc. It may cause deformation or damage of the product. Also, do not use the product in a humid or dusty environment.
- Do not drop the product or impact on the product. It may cause damage of the product.
- Do not expose the product to strong magnetic objects such as magnetic. It may cause internal data corruption or loss.
- Do not use the product with wet hands. Doing so might cause electric shock or a fault.
- Do not paint or put a sticker on a product.
- If the product smells like burning or smoke, immediately stop using the product and contact the service center. There is a risk of fire and injury.
- Please unplug USB cable when you are not using the product.
- Do not leave the product in place within the reach of small children or animals. Failure to do so might cause injury etc. if they accidentally swallow and choke on it. When the product is used by a children must be done with a careful instruction and supervision.
- Do not spray or wipe with water or chemicals. There is a risk of discoloration, breakdown and safety accident.
- Please keep important data separately. The manufacturer is not responsible for any data loss.
- The manufacturer reserves the right to change the product, such as upgrades.
- When formatting or upgrading the product, Do not disconnect the power. It may cause a system failure.
- Be sure to download the firmware through the official download site. Also, be sure to check for viruses before downloading any files and install antivirus software. The manufacturer does not provide antivirus programs.
- This product is Class B appliance, mainly intended for home use and can be used in all areas.

What's included in the package?

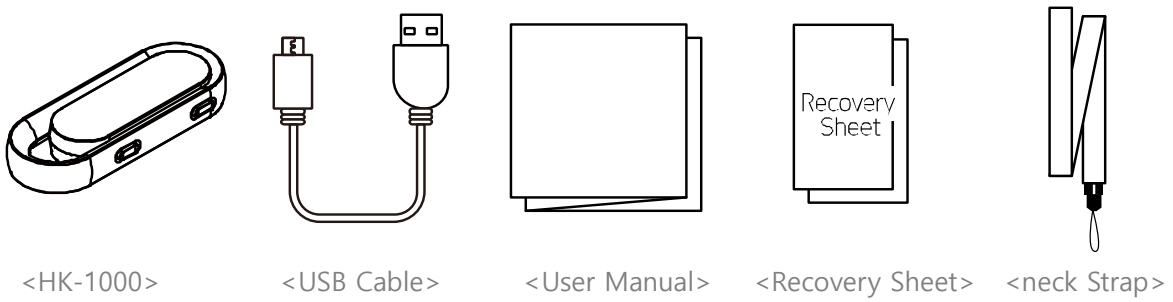

In case of loss or damage of the components, please purchase and use genuine products. If the products are not supplied or not approved by the manufacturer, the products cannot receive A / S.

<Check the each component>

- Display : the status of HK-1000 or messages for key controlling are displayed.
- Key Button : Used for Leger operation according to the instructions on the display.
- USB : USB Micro-B Port for connecting PC and HK-1000

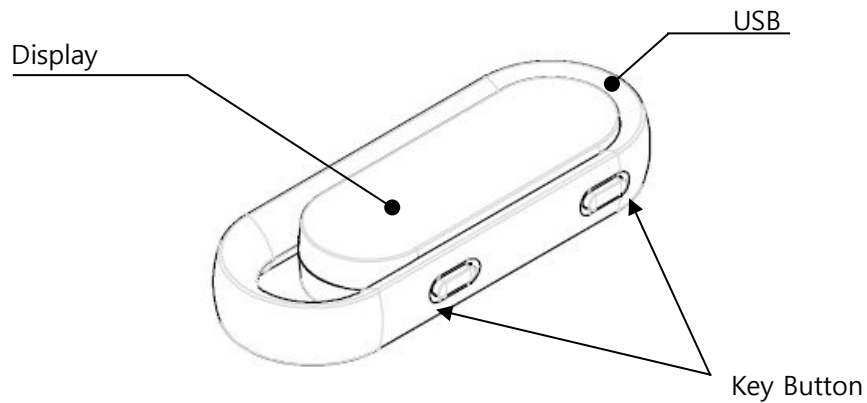

<Technical Support>

E-mail: kasse@hdactech.com

www.hd-kasse.com

Product Warranty

Product name(Model)	HK-1000	Purchasing Place	
Date of Purchase	Year___ Month___Day ___ 1-year warranty from the date of purchase		

Thanks for choosing our HK-1000.

The warranty period of this product is calculated from the date of purchase, so please be sure to indicate the date of purchase.

Service Center

HyundaiPay co.,Ltd guarantees the following products in accordance with the Consumer Damage Compensation Regulations per item (Notification No. 2000-21 of Ministry of Finance and Economy).

Service will be provided by the designated partner when requested.

Compensation will be made within 7 days from the request date, and damage compensation will be resolved within 14 days from the date of notification.

If the error occurs during the use of the product, please check the manual again and contact the service center.

Warranty Agreement

If the product fails to function normally within 1 year from the date of purchase, it will be repaired free of charge. (Check your purchase receipt)

Free warranty A / S : During the warranty period, the product will be repaired as free of charge only in case of failure due to defects in the product during normal use.

A / S : If a problem occurs during the use of the product after the warranty expired, and under the following cases, free warranty A / S is not available even within the warranty period.

- Any damages or malfunction due to customer's negligence or carelessness
- Any damages or malfunction due to unauthorized removal, maintenance, modifying, incorrect connection and replacement of the components.

- Any damages or malfunction due to natural disaster (fire, flood, earthquake, lightning, etc.)
- Any damages or malfunction due to abnormal power supply
- Any damages or malfunction due to defective connection device
- Any damages or malfunction due to repair or modification of the product by a service engineer or a service engineer who is not from the service center. The radio equipment may be confused with radio waves during operation. The warranty is valid only in Korea and cannot be reissued.

HK-1000 Specifications

Manufacturer	Hdac Technology AG
Product Name	Hardware wallet
Model Name	HK-1000
KC Identification Number	MSIP-REM-bHP-HK-1000
CPU	Cortex-M0+, 32MHz (STM32L082)
RAM	20KB
Internal Memory	128KB
Display	Passive Matrix OLED, 128 x 32
Connectivity	USB 2.0, Micro-B
Power input	5V, 0.5A
Size (mm)	60.4mm x 22.4mm x 8.2mm
Weight	11g
Operating Temperature	0°C ~ 40°C (Relative Humidity 5%~95%)

- **The manufacturer does not accept any responsibility for any loss of cryptocurrency that results from customer's neglect or misuse.**